



LARISSA

Bedroom

The Larissa bedroom is elegant, simple yet perfect. As beautiful as a nymph, from which it takes its name, Larissa presents geometric garlands and a crown as headboard top. The other items are fine, elegant, and somewhat reminiscent of the Louis XVI style, although with more worked hints. The romance of this set is ideal to furnish a refined room.

LARISSA

Art. 7741 - 7742 - 7742/1

Double bed

The Larissa collection is certainly the one with the most marked royal charm, its incomparable elegance is highlighted by the crown-shaped detail on the top of the bed. Larissa has three models that differ in the combination of headboard, footboard and bed frame. All three choices are refined and studied in detail.

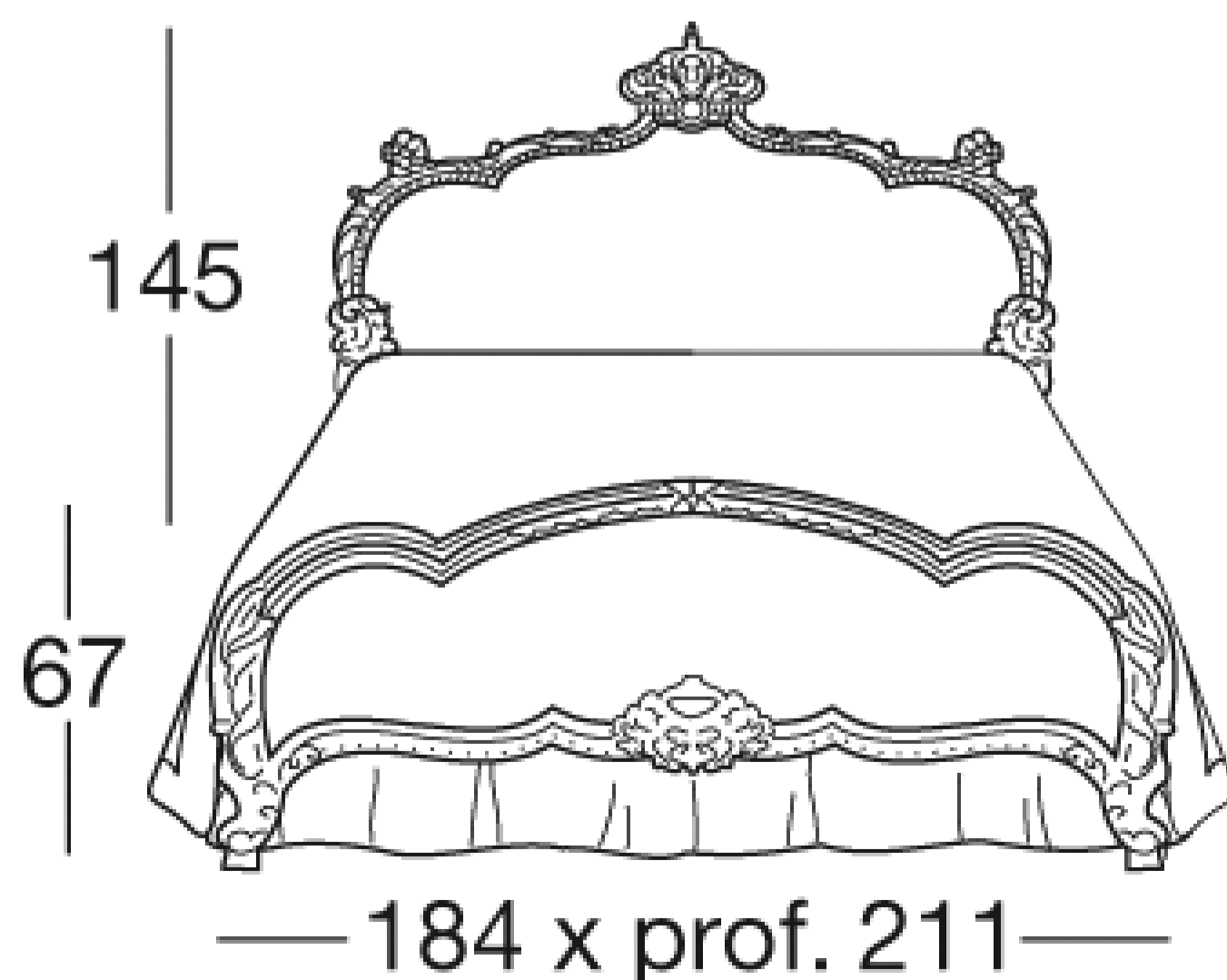

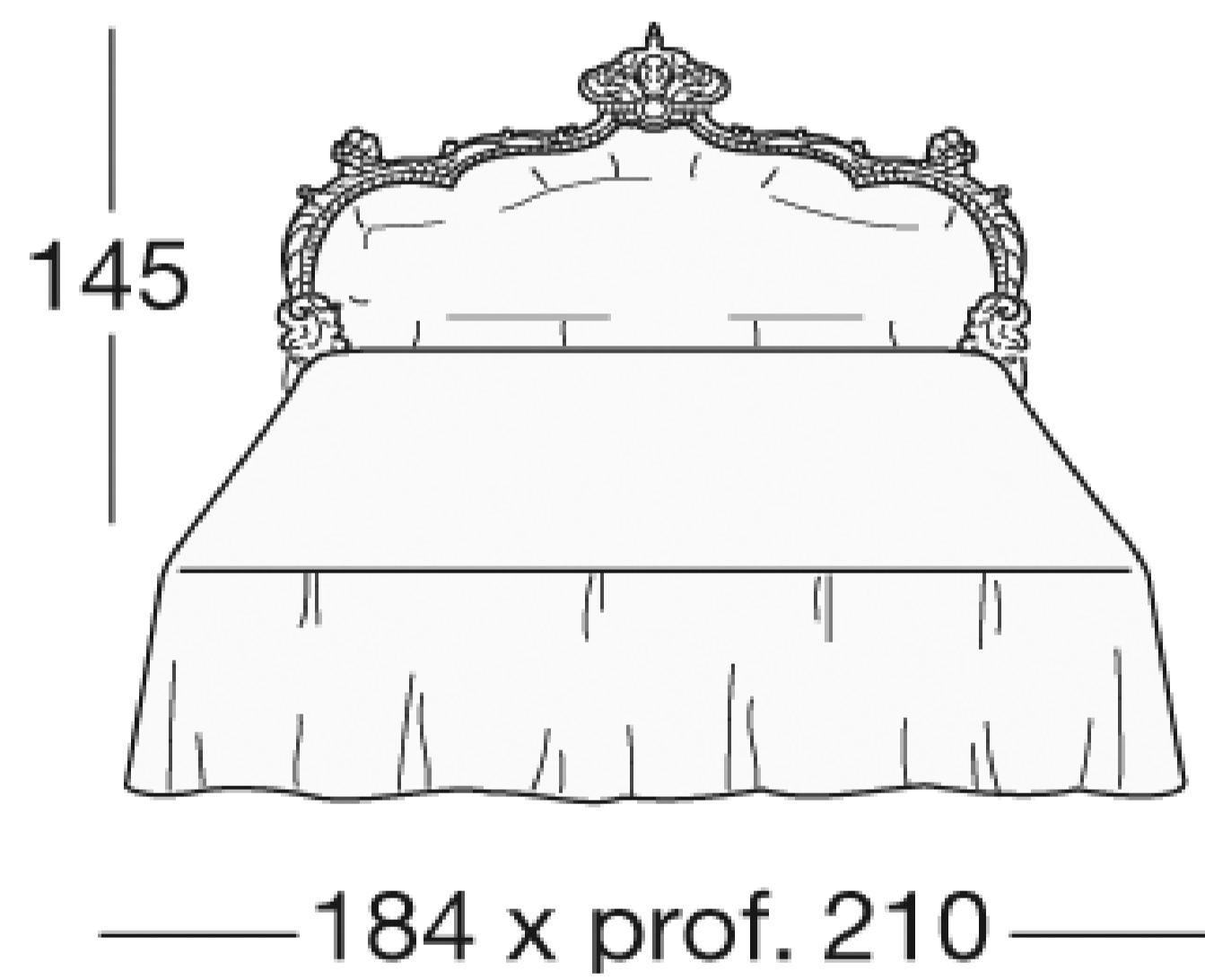
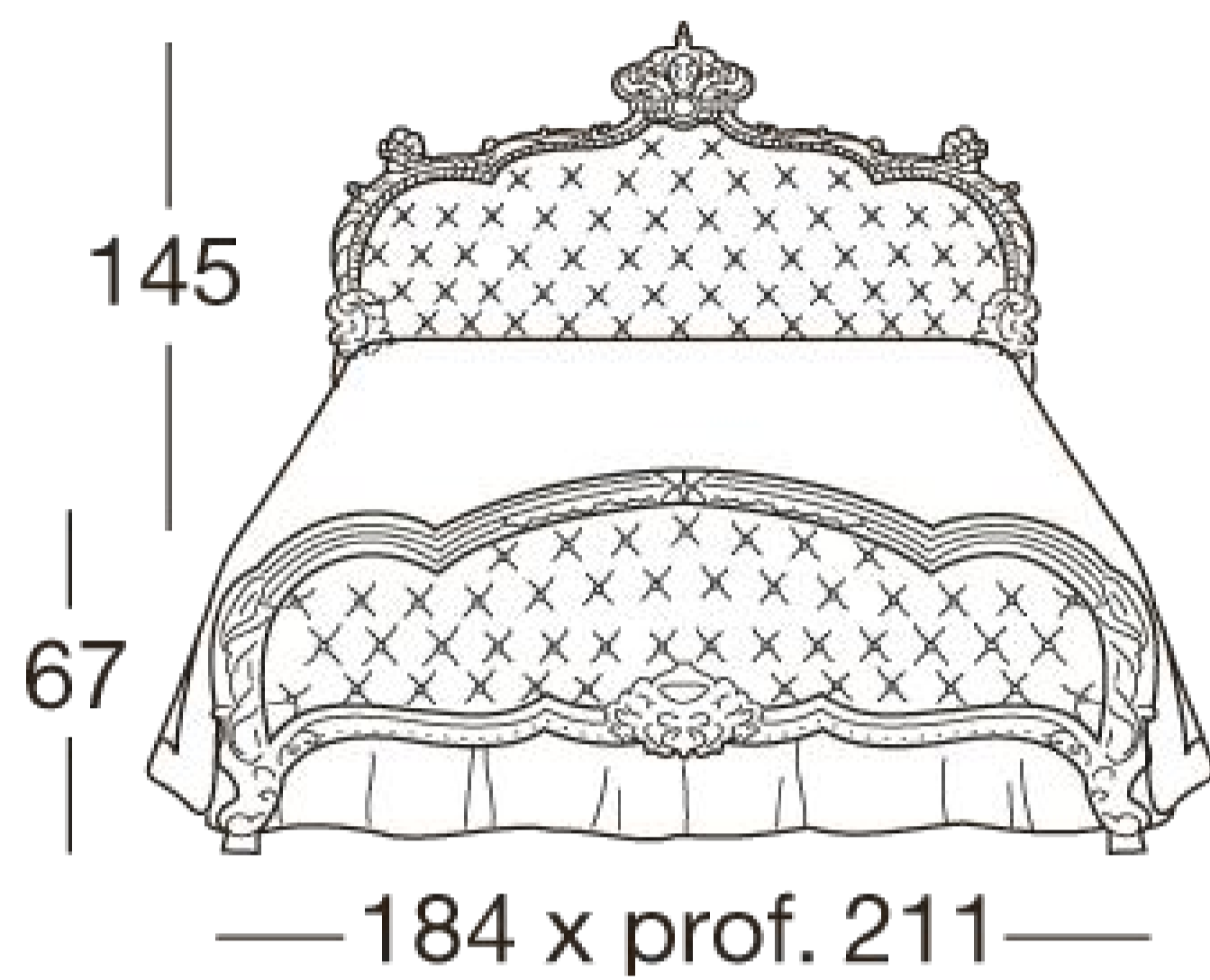

LARISSA

Art. 7743

Night table

The night table with three drawers of the Larissa collection is rather sober, linear, and elegant. It recalls somehow Louis XVI style, less worked than the Baroque but still of great aesthetic impact. Only the feet exceptionally recall the less austere style thanks to a soft and detailed curve.



56 x prof. 41

LARISSA

Art. 7740/D2-7740/S4

Wardrobe

The Larissa collection has two wardrobes that differ in shape and size. The smaller one, with only two doors, has an elegant ornamental Greek that creates a frame on the doors, while the larger wardrobe has four doors, two of which are central with mirrors framed by a Greek of leaves and flowers.

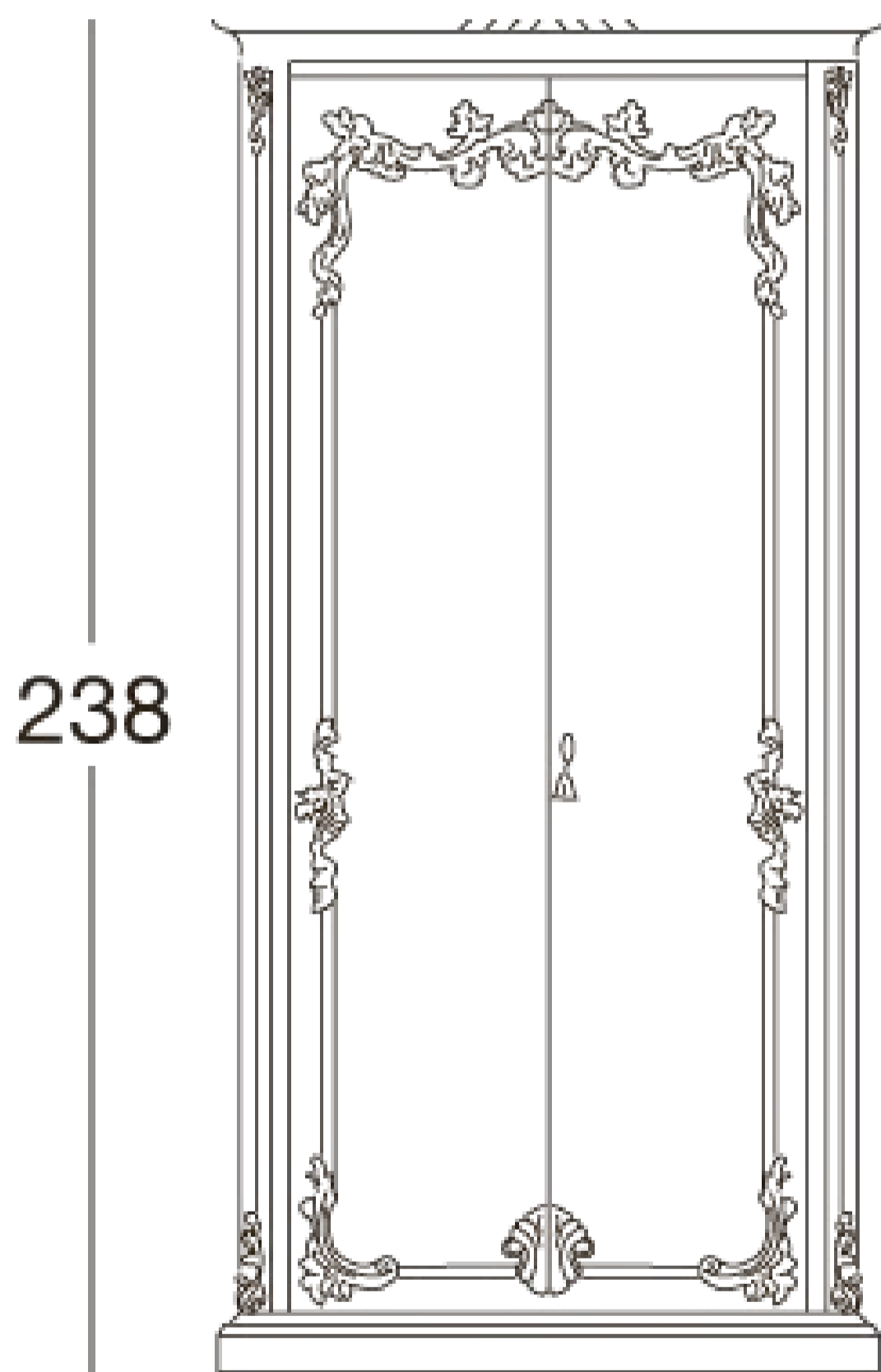

– 118 x prof. 68 –

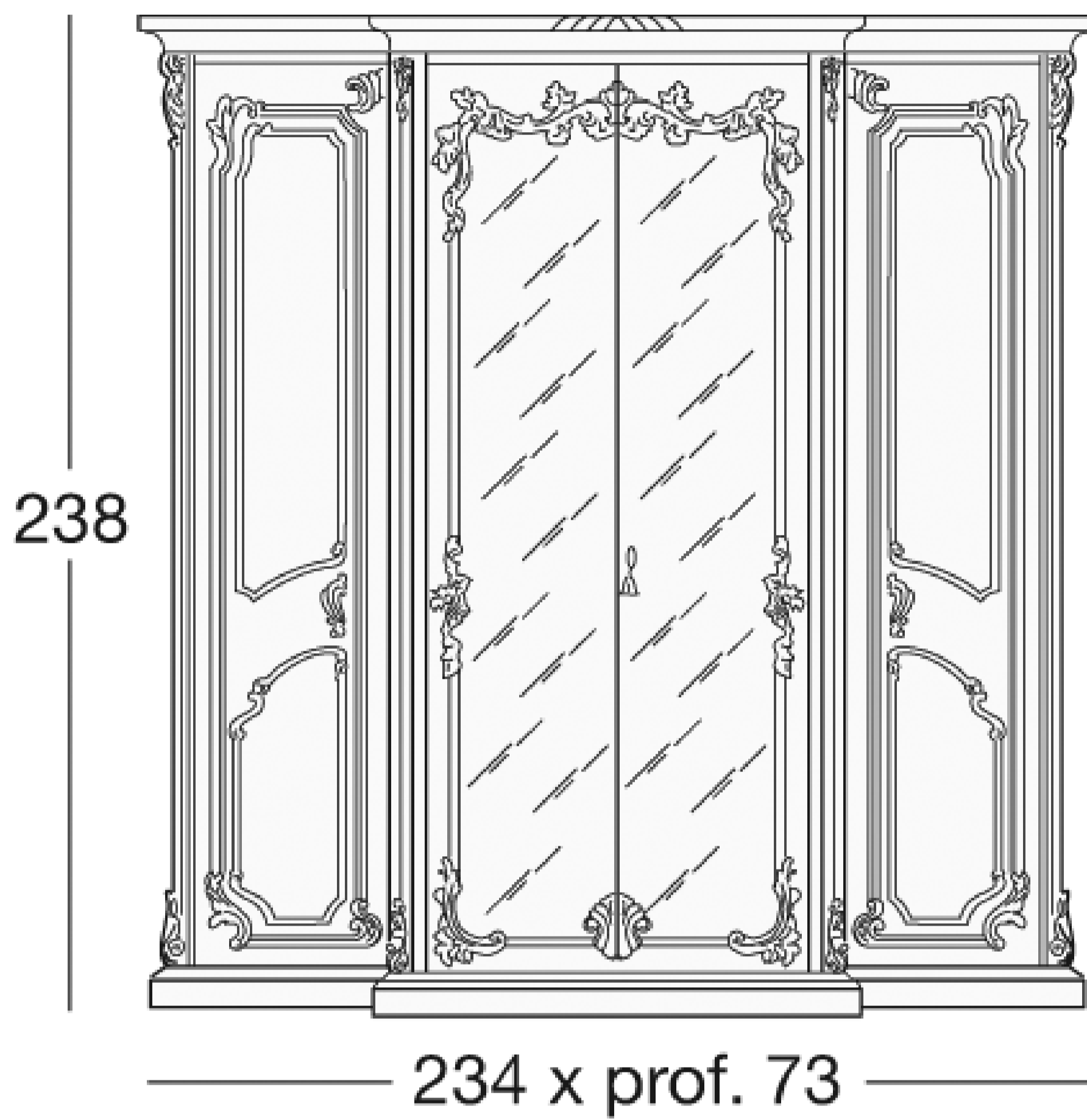

LARISSA

Art. 7745

Frame with mirror

The frame with mirror of the Larissa collection is 141 cm high and 112 cm long. What is most striking, at first glance, is the bouquet of flowers that resembles a crown, placed on top of the frame. Perfect to be placed on the dressing table of this collection is a true example of meticulous attention to detail.

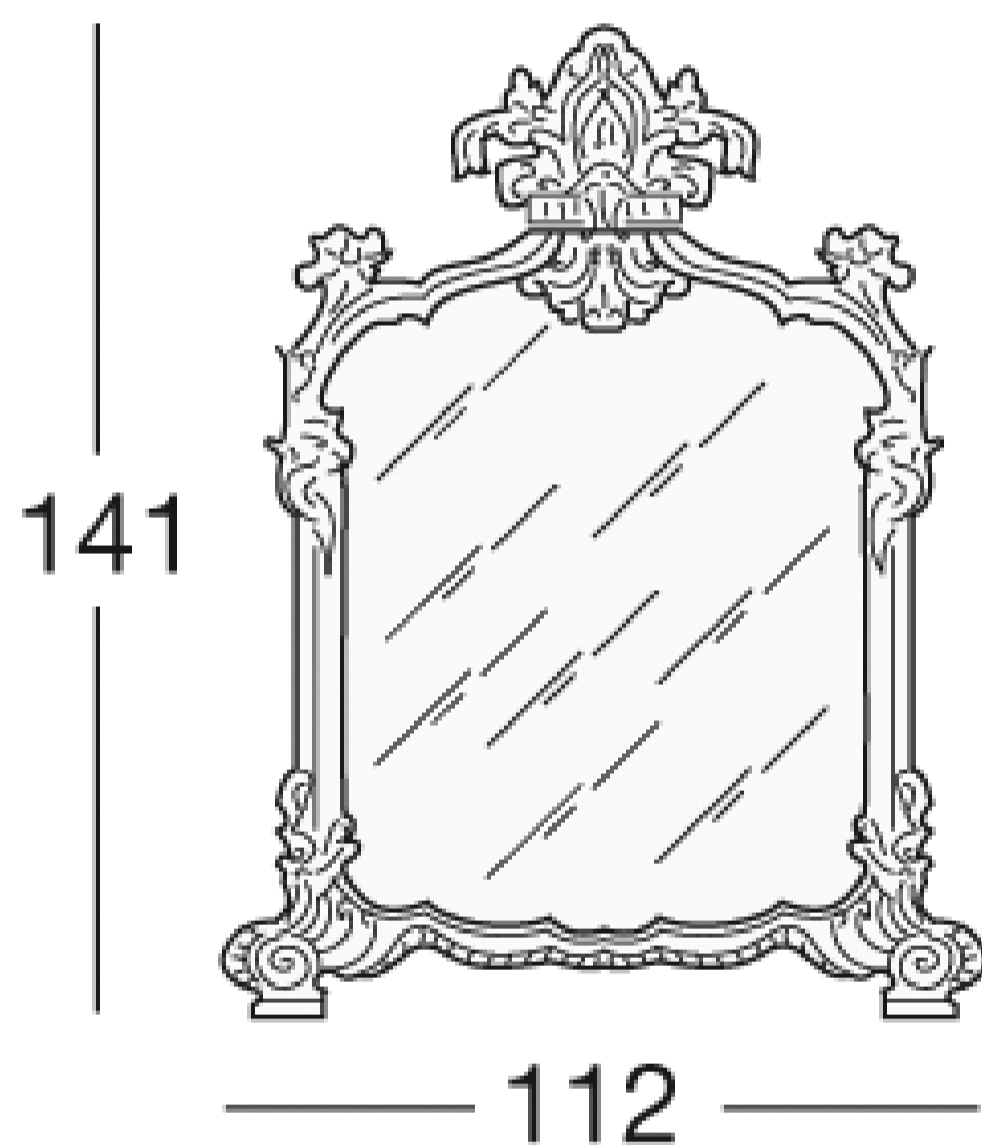

LARISSA

Art. 7746

Chest of drawers

This item has in total five drawers, the upper ones are smaller than the lower three. Due to its sizes: 91 cm high and 136 cm long with a maximum depth of 56 cm it is the ideal space for the organization of personal items. The style, identical to that of the night table, is linear apart from the gracefully curved feet. The handmade details of this article make the idea of the true Made in Italy.

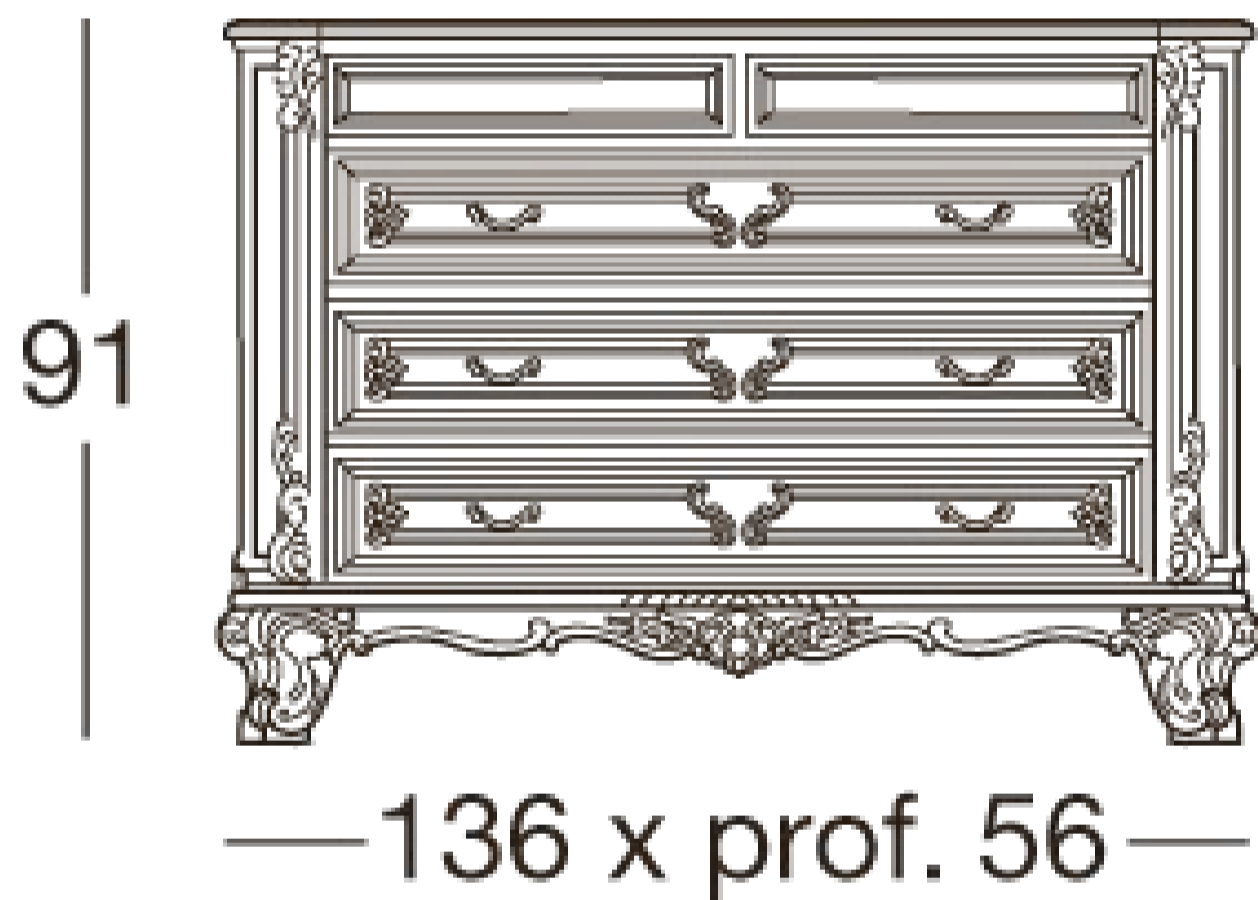

LARISSA

Art. 7747

Dressing table

Aesthetically matched with night table and chest of drawers, the dressing table of the Larissa collection also has straighter and simpler lines. The four drawers, two on each side, are added to the top and the small shelf placed immediately below. The curved and soft feet are a real touch of class that is main feature of this collection.

